

76513

76672

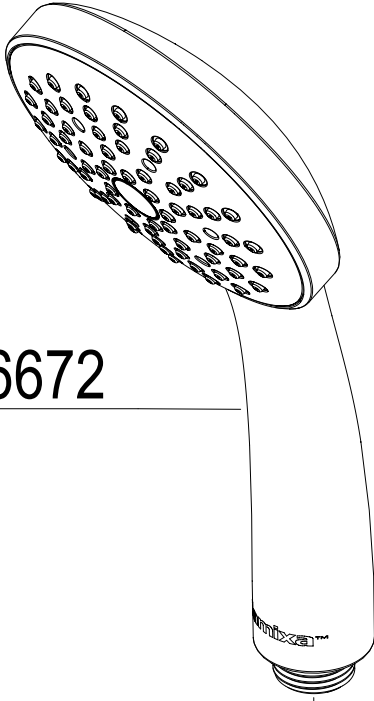

76650

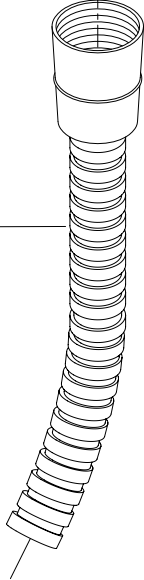

23923

